

PEAK 2000

MANUAL



Culligan International
9399 W Higgins Road, Suite 1100
Rosemont, IL 60018
(800)428-2828 www.culligan.com



PEAK 2000 MANUAL

Congratulations on your choice of the ***Culligan Peak 2000 Ice and Water Dispenser***. The ***Peak 2000*** model dispenses hot, cold, and ambient water as well as ice. The ***Culligan Peak 2000 Ice and Water Dispenser*** provides exceptional quality and great tasting water with every use.

INTRODUCTION

Carefully read and follow all instructions to ensure proper and efficient operation of your ***Culligan Ice and Water Dispenser***. Contact your ***Authorized Culligan Dealer*** if you have any questions.

Culligan and ***Authorized Culligan Dealers*** employ trained service personnel who are experienced in the installation, function, and repair of this equipment. This publication is written for use by these qualified individuals. ***Culligan*** encourages users to learn about products, however, we believe that product knowledge and service is best obtained by consulting your ***Authorized Culligan Dealer***.

Culligan Ice and Water Dispensers should be combined with selected water treatment components to create a system specifically tailored for each application by trained and qualified personnel.

Products manufactured and marketed by ***Culligan*** and its affiliates are protected by patents issued or pending in the United States and other countries.

Culligan reserves the right to change the specifications referred to in this literature at any time, without prior notice. Changes or modifications not expressly approved by ***Culligan*** could void the warranty and user's authority to operate the equipment.

TABLE OF CONTENTS

USER GUIDE

- Safety Alert Symbols 4
- Safety Precautions 4
- Features and Benefits 6
- Certifications 7
- Model Designations, Consumables, & General Specs 8
- Shipping Specifications 9
- Receiving Your Equipment 10
- Display and Control Panel 11
- Operating Instructions 13
- Warranty 14

SERVICE GUIDE

- Service Requirements 15
- Peak 2000 Parts List..... 16
- Flow Diagram 21
- Electrical Diagram 22

INSTALLATION GUIDE

- Pre-Installation Procedures 24
- Notes on Installation 25
- Filter Flushing Procedure 26
- Installation 30
- Sanitizing and Service 32
- Condensate Pump Setup..... 37
- Final Inspection 38
- Resetting Hot Tank Overload Thermostat 39

MAINTENANCE

- Preventative Maintenance 40
- System Inspection 41
- Warranty Procedure 41

TROUBLESHOOTING

- Peak 2000 Diagnostic Error Codes 42
- Peak 2000 Self-Diagnostic Mode 43
- Troubleshooting Guide 44

SAFETY ALERT SYMBOLS

Read and follow all safety information carefully. The signal words used in this manual are selected as shown below and based on an assessment of the degree of potential injury or damage (severe or minor) and the occurrence of injury (occurs or has the potential to occur) when the warning is ignored:

⚠ DANGER!

Indicates a situation which, when not avoided, results in death or severe injury.

⚠ WARNING!

Indicates a situation which, when not avoided, has the potential to result in death or severe injury; and/or severe property damage.

⚠ CAUTION!

Indicates a situation which, when not avoided, results in or has the potential to result in minor injury; and/or minor property damage.

SAFETY PRECAUTIONS

Basic safety precautions should be followed, including the following:

Ensure all Local, State, and Federal Laws and Codes including health and safety guidelines are met when installing **Culligan** Equipment. Only qualified service technicians should attempt installation and service of **Culligan** Equipment. Always read the entire operating instructions before using the appliance and save these instructions for future use.

⚠ DANGER! *This product can cause death or severe injury if incorrectly operated, installed or maintained. The installation, maintenance, sanitizing and any repair must be performed by qualified persons trained by Culligan International or their approved distributors only. Do not remove any panel or cover to protect against electrical shock and exposure to UV radiation.*

⚠ DANGER! **ELECTRICAL SHOCK HAZARD.** *Always use a dedicated and properly grounded outlet. Unit should be protected by ground-fault circuit interrupter (GFCI) or residual current device (RCD) having a rated residual operating current not exceeding 30mA. Use only **Culligan** supplied power cord. Never use extension cords or power strips to connect unit. Do not use if the power supply cord is damaged. Always unplug from power supply prior to servicing.*

⚠ WARNING! **AUTHORIZED USE ONLY.** *This appliance is to be used for its intended purpose as described in this manual. Untrained individuals who use this manual assume the risk of any resulting property damage or personal injury. This appliance can't be used by children and persons with reduced physical, sensory, or mental capabilities or lack of experience.*

⚠ WARNING! **DO NOT OPERATE IF DAMAGED.** *Unplug and isolate water supply if abnormal conditions exist. Contact Culligan or authorized dealer for repair, service, and installation to avoid hazards.*

⚠ WARNING! **HOT WATER.** *Unit produces Hot Water in excess of 80°C (175°F). Water above 52°C (125°F) can cause severe burns or scalding. Keep unauthorized people and children away from the unit to avoid accidental dispensing of hot water.*

⚠ WARNING! **CONNECT TO POTABLE WATER SUPPLY.** *This system is to be used for water only and is NOT intended for use where water is microbiologically unsafe or with water of unknown quality without adequate disinfection before or after the system.*

- ⚠ WARNING! TIP HAZARD.** *Dispenser could tip or fall causing serious injury if installed with a base. Always install unit on a firm, flat, and level surface and secure unit to cabinet, wall, or floor if needed and secure to the base, if applicable. Never place heavy items on top of unit and never climb, stand, or hang on unit or storage cabinet to prevent injury and damage.*
- ⚠ WARNING! UNIT IS HEAVY. TWO PERSON LIFT REQUIRED.** *Transport unit empty and always use material handling equipment or two people with proper lifting technique to reduce injury risk.*
- ⚠ WARNING! STORE AND TRANSPORT UNIT EMPTY. ALWAYS SANITIZE BEFORE USE.** *The unit must be completely drained before storing to avoid stagnation and reduce microbiological contamination (potential bacterial growth). Always sanitize before use to eliminate any potential microbiological contaminants.*
- ⚠ CAUTION! INDOOR USE ONLY.** *Intended for Household Use. Never expose to direct sunlight, heat sources, or ambient air temperature above 37°C (100°F) or below 2°C (35°F). Install indoors and keep unit away from excessive humidity or rain. Never expose to freezing temperatures. Ensure there is adequate clearance around the unit to allow refrigeration system condenser to dissipate heat. Warmer environments require more clearance around the unit. Minimum clearance around all surfaces of the machine is 2-inches. Installs where the ambient temperature exceeds 27°C (80°F), require a minimum of 4-inches clearance for proper heat dissipation and efficient operation.*
- ⚠ CAUTION! USE A WATER PRESSURE REGULATOR.** *Culligan will not be responsible for injury or damage caused by excessive water pressure. Input or feed pressure must be 40 psi to 80 psi. Be aware of any potential pressure surges caused by building/municipal pumping stations. Failure to comply will void all warranties. The manufacturer accepts no liability for damage caused by excessive water pressure.*
- ⚠ CAUTION! USE UV STABILIZED SUPPLY LINES.** *Feed the unit with a potable ambient or cold-water supply only. Feed water over 37°C (100°F) can damage the treatment components. Water block devices and external leak detectors are strongly recommended. Locate the unit as close to the water supply and the electrical connections as possible. Immediately isolate or close water supply valve and contact service representative if leak is noticed.*
- ⚠ WARNING! REFRIGERANT SYSTEM.** *This system is manufactured with 134A refrigerant. Repairs to the refrigeration system must be performed by a certified refrigeration technician only.*
- ⚠ CAUTION! DO NOT PLACE HEAVY ITEM OR WATER CONTAINER ON TOP OF UNIT.** *Water may leak into the electrical system causing a fire hazard. Heavy items may fall off causing injury.*

Contact Culligan for assistance or help finding an Authorized Service Representative.

Peak 2000 FEATURES AND BENEFITS

Hot, Cold, Ambient Water and Ice

The *Peak 2000 Ice and Water Dispenser* comes standard with Hot, Cold, and Ambient Water Selections to meet a wide range of customer demands, and also dispenses Ice.

Water Capacity and Production

The *Peak 2000 Ice and Water Dispenser* holds 1.2 gallons (4.6L) of Hot Water, 1.2 gallons (4.6L) of Cold Water, 4.5 gallons (17L) of Ambient Water, and almost 9 pounds of Ice with a production rate of 44 pounds per day.

Large Dispense Area with Recessed Faucet

10-inch dispense height with recessed faucet to protect from cross-contamination.

Leak Prevention

Peak 2000 Ice and Water Dispensers are supplied with a leak stop device to cut off the water supply in the case of a water leak or overflow.

Hands-free Touchless Dispensing

Touchless Capacitive Sensors use Infrared Technology to activate select and dispensing functions.

Temperature Indicator Light

Light above dispense nozzle changes color to indicate water temperature being dispensed (Blue for Cold, Red for Hot, White for Ambient)

Drip Tray Drain

Unit comes with a drain connection to the Drip Tray.

RO Water Filtration

The *Culligan Peak 2000* uses a 5-stage RO filtration configuration for great tasting water and ice, and implements dual RO membranes, to increase production rate.

Cold Water Overnight Filtering

The *Culligan Peak 2000* will recirculate the Cold water through the filtration system during night hours to keep the cold water fresh, clean, and tasting great.

CERTIFICATIONS

Peak 2000 Ice and Water Dispensers have been tested and certified to rigorous NSF and UL Standards. We believe that performance testing and certifications validate *Culligan* as a world-leader in Ice and Water Dispensers.

Culligan Peak 2000 Component Certifications Include:



Intertek

UL399 – Certified Drinking Water Cooler

Intertek Labs (ETL) Certified the *Peak 2000 Ice and Water Dispenser* to ANSI/UL 399 Standard for Drinking Water Coolers.

UL563 – Certified Ice Makers

Intertek Labs (ETL) Certified the *Peak 2000 Ice and Water Dispenser* to ANSI/UL 563 Standard for Safety Ice Makers

CSA C22.2 No. 120 CSA Standard for Refrigeration Equipment

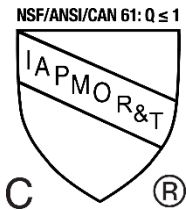

NSF/ANSI 372 – Drinking Water System Components – Lead Content

The *Culligan Peak 2000 Ice and Water Dispenser* system is certified by IAPMO R&T against NSF/ANSI/CAN 61 and 372 for Lead Free Requirement, and CSA B483-1.



MODEL/PART DESIGNATIONS

BRAND NAME	DESCRIPTION	MODEL - PART NUMBER
<i>Peak 2000</i>	<i>Peak 2000</i> – Hot, Cold, Ambient, Ice	D1045477
	Z10570-(YYMMDD)-00(XXX)	

CONSUMABLES

FILTER	REPLACEMENT FREQUENCY	PART NUMBER
SEDIMENT FILTER	6-12 MONTHS	D1043985
PRE-CARBON FILTER	12 MONTHS	D1043986
RO MEMBRANE (x2)	TEST TDS REDUCTION AT 12 MONTHS	D1043987
MINERAL FILTER	12 MONTHS	D1043988
AIR FILTER	2 YEARS	D1042467

SPECIFICATIONS

<u>ITEM</u>	<u>Peak 2000</u>
Water Connection	¾" Quick Connect
Recommended Service Water Pressure	50-70psi (0.5-7kgf/cm ²)
Rate Voltage	AC 120V/60Hz @ 4.9Amps
Power Consumption	1.2A (120W) Cold Water & Ice Making; 500W Hot Tank; 6.0A (720W) Max
Power Cord	1.9m (6.3ft)
IP Class	IPX1
Climate Class	N Class (32°C +/- 1°C) (89.6°F +/- 33.8°F)
Safety Device	Overheating protector. Water Level Detector. Leak Stop Device. Fuse.
Hot Tank Capacity	1.2gal (4.6L)
Ambient Tank Capacity	4.5gal (16.9L)
Cold Tank Capacity	1.2gal (4.6L)
Ice Production	44 lbs/day (19.9 kg/day)
Ice Storage Capacity	8.8 lbs (4 kg)
Environmental Temperature	Max: 90°F (32°C) Min: 35°F (2°C)
Source Water Temperature	Max: 90°F (32.2°C) Min: 40°F(4.5°C)
Relative Humidity	55% at 78°F(25.5°C)
Refrigerant Gas	R134a (3.10oz +/-0.03oz)
R134a Pressures	186Psig (12.8bar) High Side, 88Psig (6.1bar) Low Side

SHIPPING SPECIFICATIONS

<u>ITEM</u>	<u>Peak 2000</u>
Width/Depth/Height	430mm W x 492mm D x 1490mm H 16.9" W x 19.4" D x 58.7" H
Weight (dry)	118lbs (53.7 kg)



RECEIVING YOUR EQUIPMENT

Upon receipt of your equipment, you should check the following:

1. Are the systems still on the pallet?
2. Confirm the number of boxes you are signing for.
3. Is there any obvious damage to the product or the boxes?

If there are any discrepancies or any obvious damage to the equipment or boxes, please note it on the “Bill of Lading” and/or refuse the shipment.

After receiving the equipment from the carrier, remove packaging and inspect for any hidden freight damage. If freight damage has occurred, call Echo to report the damage and follow their claim process as outlined on CPort. Photograph all damages to be submitted with the claim. **THIS MUST BE DONE WITHIN 24 TO 48 HOURS OF DELIVERY.** If not reported within 2 business days, Culligan and/or carrier will not be responsible for replacement or repair.

DISPLAY & CONTROL PANEL

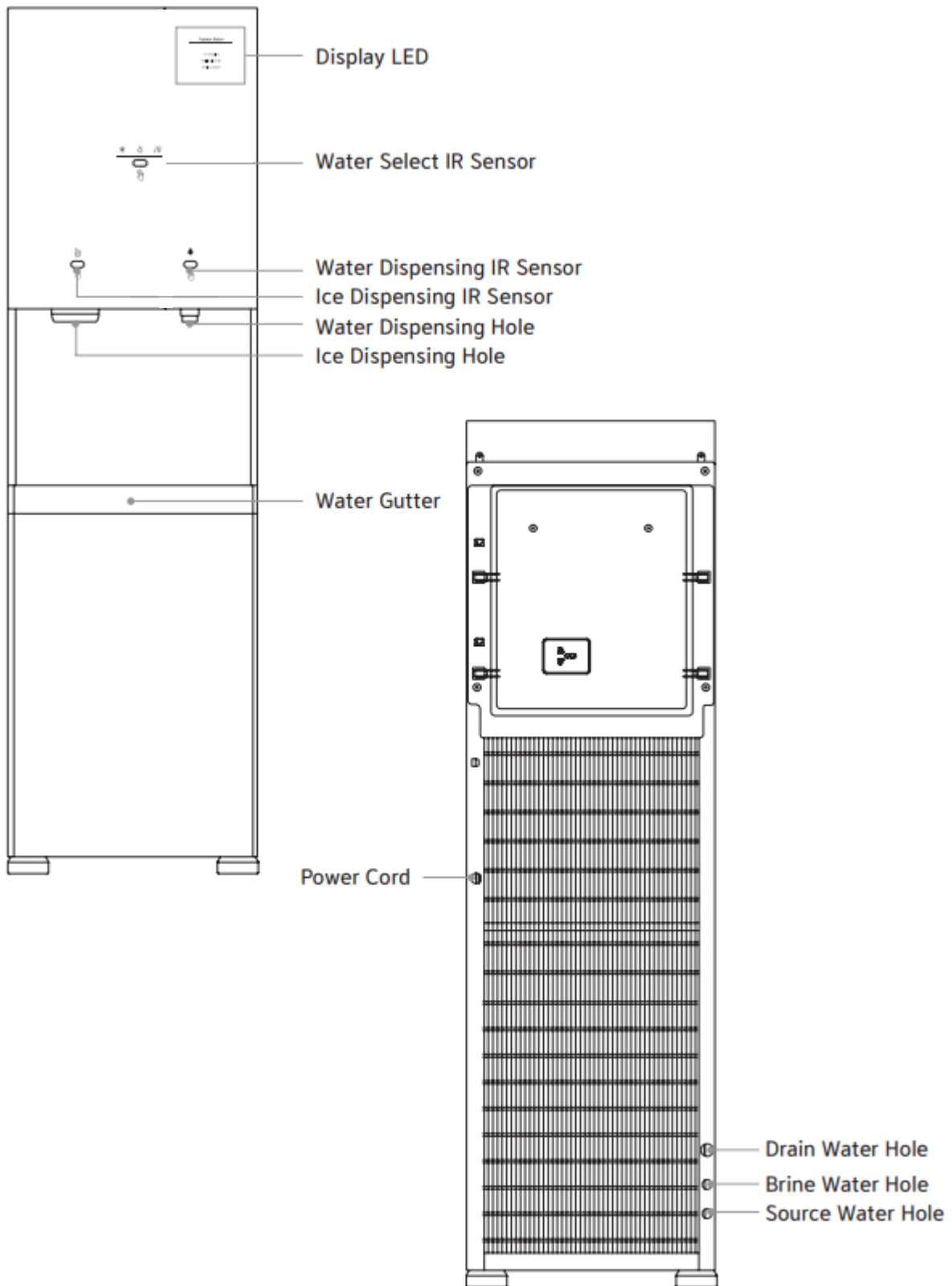

Display LED

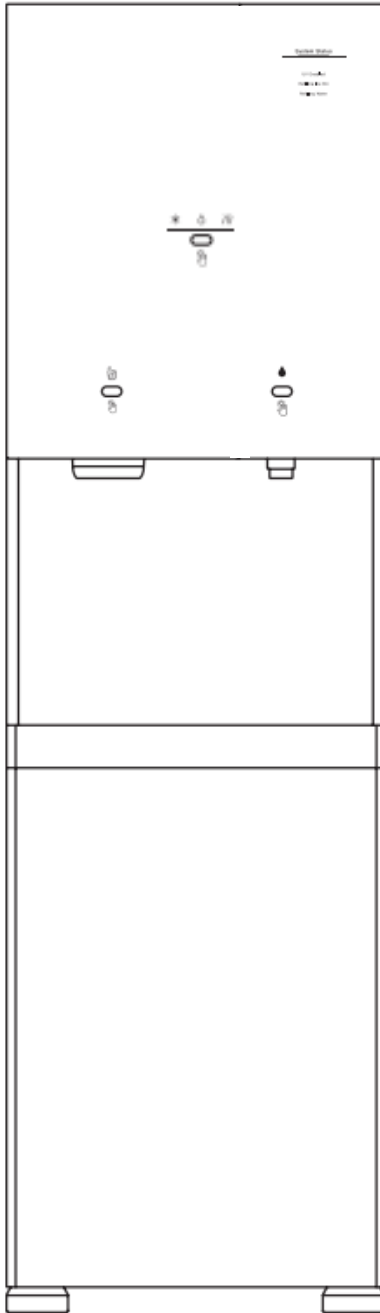

Filtration Active	Always On
UV Enabled	Always On
Refilling Ice Bin	Lights up during the ice-making process. (LED: White)
Refilling Water	Light up during the water filtering process. (LED: White)

IR Sensor & LED

	Water Select IR Sensor	Put your hand close to the Water Select IR sensor to select Cold/ Ambient/ Hot water respectively. Selected LED lights up. (* Cold : Blue, ◊ Ambient : White,))) Hot : Red)
	Ice IR Sensor	Put your hand close to the Ice IR sensor to dispense ice.
	Water Dispensing IR Sensor	Put your hand close to the Water Dispensing IR sensor to dispense selected water. (◊ Cold : Blue, Ambient : White, Hot : Red)

OPERATING INSTRUCTIONS

The below pictures show the front user interface (UI) and control panel for the *Peak 2000 Ice and Water Dispenser*, as well as the Beep Operation Signal table.

Operation beep sound

※ A beep sound following operation of the product.

	Division	BEEP	Remarks/occurrence
①	Power ON	Ding dong dang~	once
②	Key input	Ding~	once
③	Water Dispensing Start	Ding~	once
④	Water Dispensing Ending	Ding~	once
⑤	Overflow	Ding~ding~ding~ding~	One second interval
⑥	Ice dispensing	Ding~ding~ding~ding~ding~	once

To Select Water:

Place your hand close to the WATER SELECT IR SENSOR. Move your hand away and back to the sensor to select the next option. **Cold Water → Ambient Water → Hot Water** is the selection order.

*Your hand should be 3-4cm away from the sensor to activate.

*Move your hand back and forth to cycle.

*If the sensor does not detect motion for more than 5 seconds, it will switch to the default mode (Cold Water).

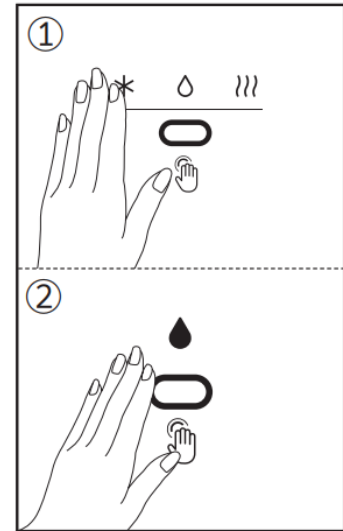

To Dispense Water:

Place your hand close to the DISPENSE IR SENSOR (Right Sensor) and hold there to dispense. Remove your hand to stop.

*If both sensors (SELECT & DISPENSE detect any motions simultaneously, then the unit will recognize this as an error and will not operate.

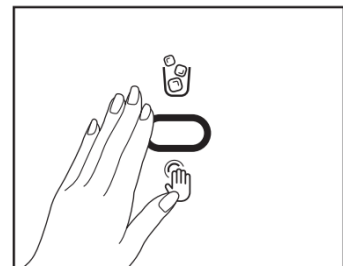

To Dispense Ice:

Place your hand close to the ICE DISPENSE IR SENSOR (Left Sensor). Hold your hand in place to dispense ice, remove to your hand to stop.



CULLIGAN MANUFACTURED ICE AND WATER DISPENSER LIMITED WARRANTY

Equipment Warranty

For ice dispenser model Peak 2000 (the “Warranted Ice Dispenser”):

Culligan agrees to provide a one (1)-year limited warranty to the Dealer with respect to the Warranted Ice Dispenser, beginning on the date of sale to the Dealer hereunder. Subject to the terms below, Culligan agrees to issue the Dealer a credit equal to the cost of the defective part associated with the Warranted Ice Dispenser at no cost to the Dealer during the term of the Equipment Warranty.

Filter Warranty

Culligan warrants, for a period of one (1)-year from the date of sale to the Dealer (the “Filter Warranty”), that the filters sold hereunder will be free from material defects in workmanship or materials. Subject to the terms below, Culligan agrees to replace any filter deemed to have a material defect at no cost to the Dealer during the term of the Filter Warranty.

Exclusions and Conditions

The foregoing warranties do not cover: (i) parts that malfunction, in Culligan’s determination, as a result of external damage or corrosion, neglect, modification or abuse; (ii) Cosmetic Parts (as defined below); or (iii) any Product exported, sold, shipped or delivered to any place or location outside Dealer’s Service Locations. The Equipment Warranty does not apply, and no agreement, either written or implied, shall be applicable if the affixed serial number is removed, defaced or obliterated. Further, the Equipment Warranty does not apply to any wetted parts that become inoperative due to lime, scale, or other water quality conditions. A “Cosmetic Part” shall mean any of the following part types: top cover, front upper panel, front lower panel, drip tray and grill, side panels, footings and system backing.

Culligan reserves the right to reject any warranty claim to the extent: (i) Dealer fails to install or service the Warranted Water Cooler or Warranted Ice Dispenser in accordance with (A) applicable laws and regulations, including relevant building codes, and (B) the maintenance requirements set forth in the service manual; (ii) Dealer uses non-Culligan filters or parts at any time during the applicable warranty period; or (iii) the Warranted Water Cooler, Warranted Ice Dispenser, or warranted filter is installed or used in a manner that is inconsistent with the relevant Product labeling, specifications, documentation or service life, as applicable.

Claims Submission

Follow Culligan’s standard RMA process through CPort.

SERVICE REQUIREMENTS

⚠ WARNING! *Read and understand the contents of this manual before attempting to service the Peak 2000 Ice and Water Dispenser. Failure to follow the instructions in this manual could result in death, serious personal injury, or severe property damage. Only trained and qualified technicians should attempt to install, maintain, or service Culligan Equipment.*

1. Visually inspect all electrical and water connections for signs of wear or damage.

⚠ DANGER! *HIGH VOLTAGE ELECTRICAL HAZARD. Unplug before inspection and service.*

⚠ WARNING! *ULTRAVIOLET RADIATION. Protect your skin and eyes against ultraviolet rays. Never look directly at an operating UV light. Disconnect before removing UV Lamp.*







⚠ CAUTION! *UV LIGHTS ARE HAZARDOUS. Lamps are considered Hazardous Waste and must be disposed of accordingly. Refer to Product MSDS sheet for details.*

2. Ensure there is adequate (minimum of 5") clearance around the **Peak 2000 Ice and Water Dispenser** and clean the condenser grill to provide efficient cooling system operation.
3. Sanitize the unit per instructions in the sanitization procedures.

⚠ WARNING! *SANITIZER MAY CONTAIN HAZARDOUS CHEMICALS. Use of proper personal protective equipment such as rubber gloves and eye protection are required.*

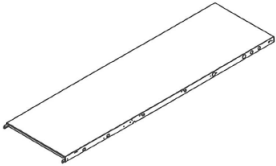
4. Clean and sanitize external surfaces of the **Peak 2000 Ice and Water Dispenser**. Use soap and water or chemicals that are compatible with ABS plastic and will not damage or degrade the product surfaces.
5. Remove and clean the Faucet. Replace as needed.
6. Flush in filters per instructions, and change filters on predetermined schedule, commonly every 12 months for standard filters.

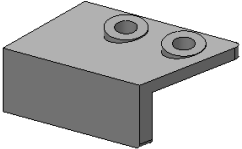
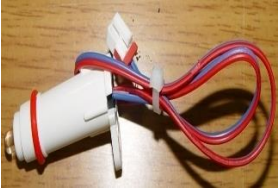
PEAK 2000 PARTS LIST

No.	Part No.	Description	Rec' Stock	Photo
1	D1043581	FLOAT VALVE ¼" CONNECTIONS	2	
2	D1043953	BOOSTER PUMP	1	
3	D1043955	SIDE PANEL (L)	0	
4	D1044003	ICE STORAGE BASKET	0	
5	D1043957	ICE DISCHARGE BLADE FIN	0	
6	D1043958	ICE DISCHARGE BLADE FIN BRACKET	0	
7	D1043960	ICE FULL SENSOR - TRANSMITTER	1	
8	D1043961	ICE FULL SENSOR - RECEIVER	1	

9	D1045784	STERILIZER UV LED	2	
10	D1044034	ICE TRAY MOTOR COUPLING	2	
11	D1043962	CIRCULATION PUMP ASSY	0	
12	D1043963	COLD WATER LEVEL SENSOR	1	
13	D1043964	COLD WATER TEMPERATURE SENSOR (COOLING SENSOR)	1	
14	D1043966	WATER SUPPLY SOL VALVE ASSY	0	
15	D1043968	WATER DISPENSE SOLENOID V/V	1	
16	D1043969	ICE TRAY MOTOR (SPECIAL ORDER)	0	
17	D1044035	ICE DISCHARGE DOOR ASSEMBLY (SPECIAL ORDER)	0	

18	D1045785	ICE DISPENSE BLADE MOTOR (SPECIAL ORDER)	0	
19	D1044011	COLD MANIFOLD	0	
20	D1043972	DISPENSE WATER SOLENOID	1	
21	D1043978	HOT TANK ASSY	0	
22	D1042467	6-IN AIR FILTER (SEDIMENT)	24mo	
23	D1046190	MAIN PCB (V.1.0)	0	
24	D1043994	CAPACITIVE WATER LEVEL SENSOR	0	
25	D1043982	SURROUNDING TEMP SENSOR	1	
26	D1043989	AUTO FLUSHING VALVE	1	

27	D1043990	RAW WATER SOLENOID V/V	1	
28	D1043985	SEDIMENT FILTER	PM	
29	D1043986	PRE CARBON FILTER	PM	
30	D1043988	MINERAL FILTER	PM	
31	D1043987	RO MEMBRANE FILTER	PM	
32	D1045786	DRAIN SOLENOID VALVE	1	
33	D1045787	FRONT MID COVER ASSY	0	
34	D1045788	FRONT-UPPER ASSY (PEAKV2)	0	
35	D1045789	COVER FRONT-UPPER SPRAY (SILVER)	0	

36	D1045790	WIRE DC #7	0	<p>To: Yearcho Housing: 12507HS-06L Terminal: 12507TS</p> <p>To: Yearcho Housing: 12507HS-06L Terminal: 12507TS</p>
	D1045791	WIRE DC #9	0	<p>To: Yearcho Housing: 15007HS-06P Terminal: 15007TS</p> <p>To: Yearcho Housing: 15007HS-06P Terminal: 15007TS</p>
	D1045792	SHEET LOGO TOP		
37	D1045793	IR SENSOR	0	
38	D1045794	REAR COVER	0	
39	D1045795	TOP COVER (PEAKV2)	0	
40	D1045796	FRONT LOWER COVER ASSY	0	
41	D1045797	DRIP TRAY ASSY (PEAKV2)	0	

PEAK 2000 WATER FLOW DIAGRAM

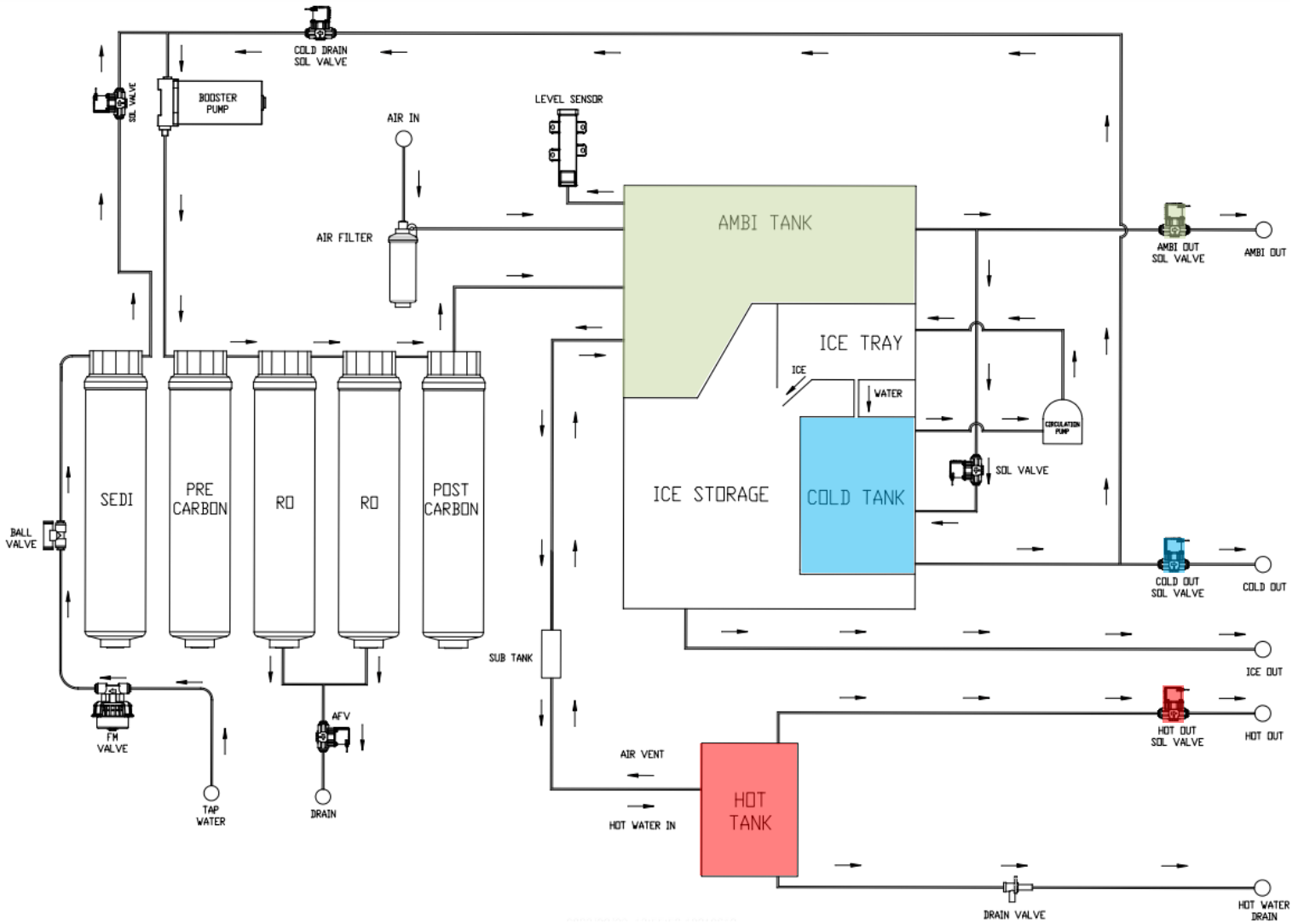

PEAK 2000 ELECTRICAL DIAGRAM

⚠ DANGER! HIGH VOLTAGE ELECTRICAL HAZARD. PCB (Printed Circuit Board) contains High Voltage. Only trained and qualified technicians should attempt live testing.

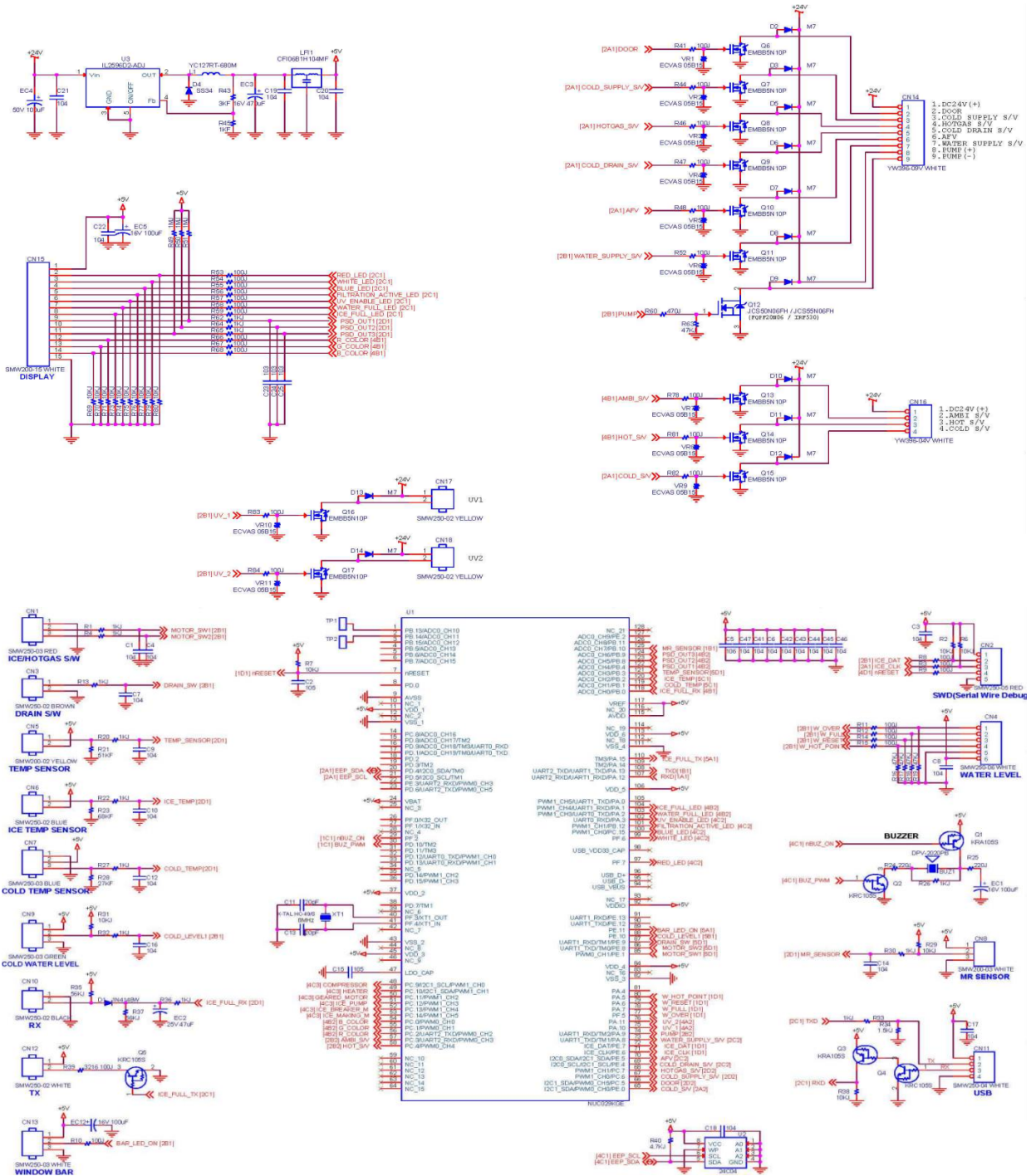

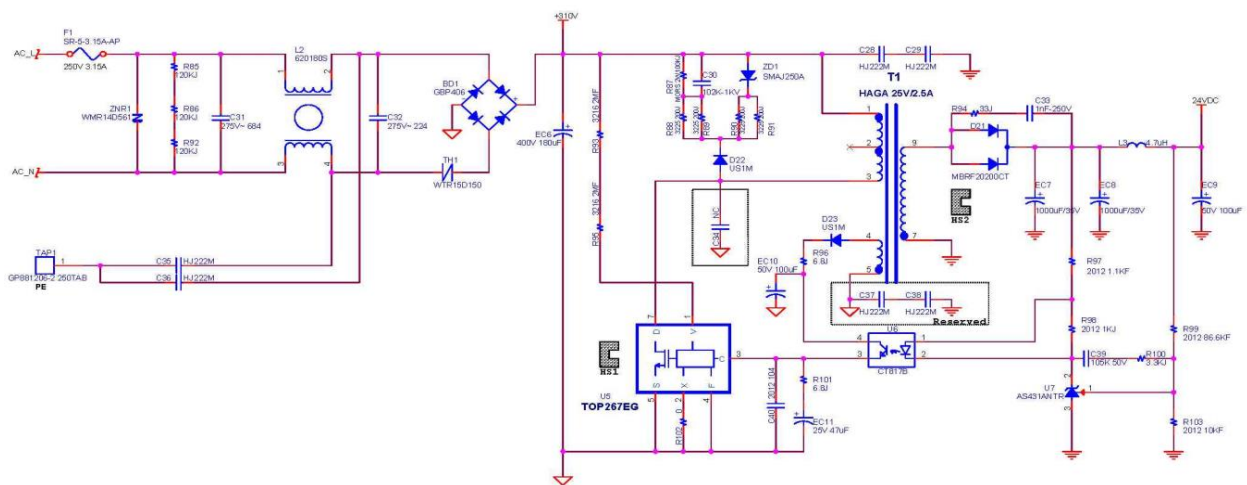
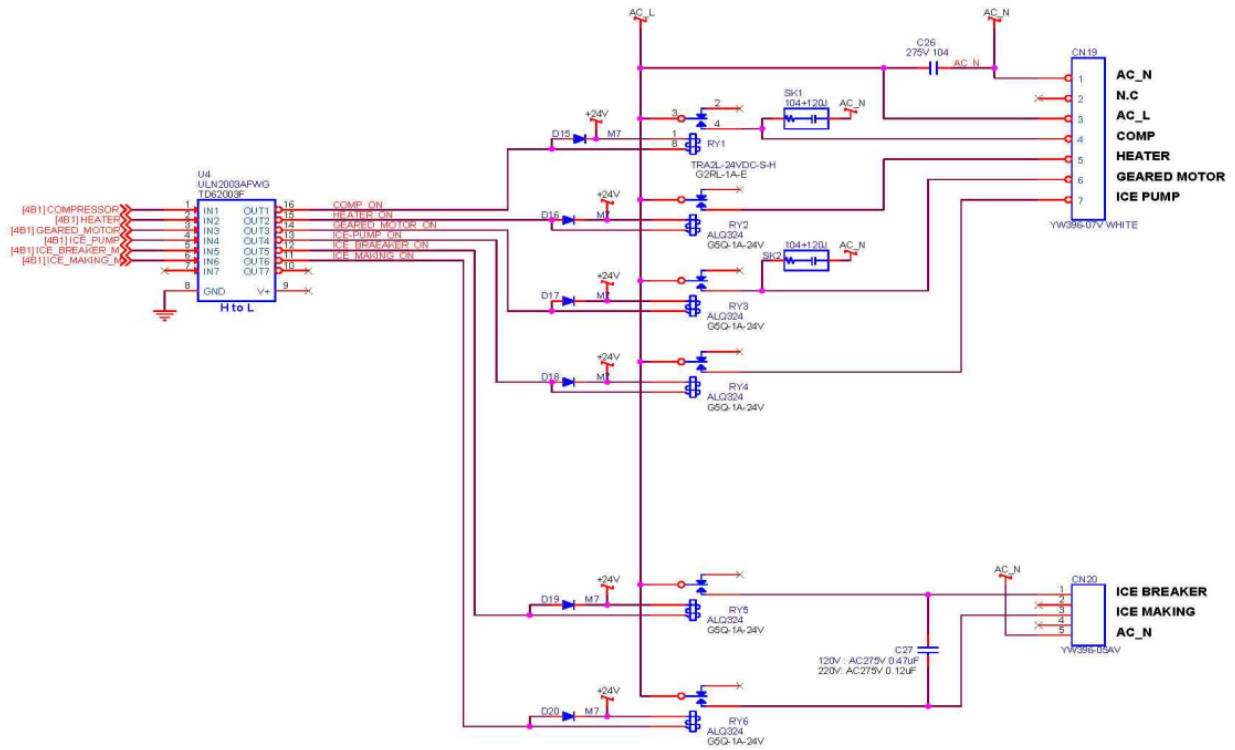

PRE-INSTALLATION



DANGER! ELECTRICAL SHOCK HAZARD.

*Only qualified personnel who have read and understand this entire manual should attempt to install, or service this **Peak 2000 Ice and Water Dispenser**, failure to do so could result in death or serious injury. DO NOT plug into an electrical supply until specifically instructed.*



WARNING! ALWAYS SANITIZE BEFORE USE.

Sanitize before use to eliminate any potential microbiological contaminants.

Materials Needed:

- Personal Protective Equipment. Rubber or Nitrile Safety Gloves and Protective Eyewear
 - Phillips Screwdriver
 - Temperature Gauge
 - Water Pitcher or Container to collect water from the faucet
 - 5-gallon container or drain basin
 - Sanitizer - Household Bleach (5.25% Sodium Hypochlorite) or Citric Acid Based Cleaner
 - ¼" Plastic Tubing, at least 10 feet in length, and assorted ¼" quick connect fittings
 - TDS Meter and Test Strips for measuring chlorine – Optional
1. Unpack the **Culligan Peak 2000 Ice and Water Dispenser** and check exterior for damage.



CAUTION! FILTER FLUSH REQUIRED.

Peak 2000's Ice and Water Dispensers are supplied with filters. The frequency of filter changes depends upon your water quality and your water usage. For example, if there is a lot of sediment and/or particles in your water, then you will have to change your filters more frequently than a location with little to no sediment. Be sure to replace your filters whenever you notice a decline in the performance, whether it is a drop of flow rate and/or pressure or an unusual taste in the water.

2. Flush filters thoroughly per filter manufacturers' recommendation with fresh water to drain. More details provided in the **Filter Flushing** section further down.

NOTE: Filters should not be flushed prior to 24 hours before installation to limit Microbial Growth inside of filters.

NOTES ON INSTALLATION

1. Do not install the product at the following locations:
 - Near Fires
 - Near Flammables
 - In Humid Places
 - In front of air conditioners
 - Where exposure to rain or snow is possible
 - Outdoors or in direct sunlight
 - Near chemicals (volatile materials, organic solvents, etc.)
 - Near toilets
 - Anywhere the temperature may fall below 50°F.
2. Use source water within following quality range:
 - Water pressure: 50-70psi
 - Water temperature: 39-100°F (4-38°C)
 - Turbidity: 0.5 NTU or less
 - pH: 5.8-8.5
 - Hardness: 300ppm or less
 - Water Quality: Water quality meeting the Drinking Water Quality standard

*The warranty will be void if the product is connected to source water that is out of the specified range.

*This product is not equipped with internal filtration. It is intended to be connected only to a potable water source.

3. When transporting the product, do not tilt it more than 45° from vertical.
 - *Severe tilting can cause a performance degradation.
4. Install the product on a flat surface and adjust the level of the unit using a level gauge.
 - *If the product is tilted more than 3°, overflow may occur.
5. Source water should not be above 100°F (38°C)
 - *Hot water may cause performance degradation or system failure.
6. Keep the sides and rear of the unit at least 5 inches (127mm) away from walls or other objects for ventilation.
7. Do not bend the source water or drain hose or place heavy objects on them.
 - *If either are blocked, the water will not flow smoothly to and from the unit, and may cause performance degradation.
8. Do not place any heating system near the rear of the unit.
9. The power supply, source water, and drain must be directly connected to the unit.

FILTER FLUSHING PROCEDURE

It is important to flush all filters inside the **Peak 2000** unit prior to installation. This will flush any carbon fines and preservative from the filters and extend the life of the filters as well reduce the potential of blockages and improve the quality of the water.

Shown below are the filters installed as they come in the unit from the factory.



1. Shut off the 1/4-turn valve just before the water reaches the filter manifold circled in red in the photo below. Connect the water supply to the machine using LLDPE 1/4" tubing and turn on the supply. Disconnect the white tube at the location circle in yellow.
2. Take a 2-3ft piece of 1/4" LLDPE tubing, and place it into the same port, run the other end to a drain or bucket, as shown below.

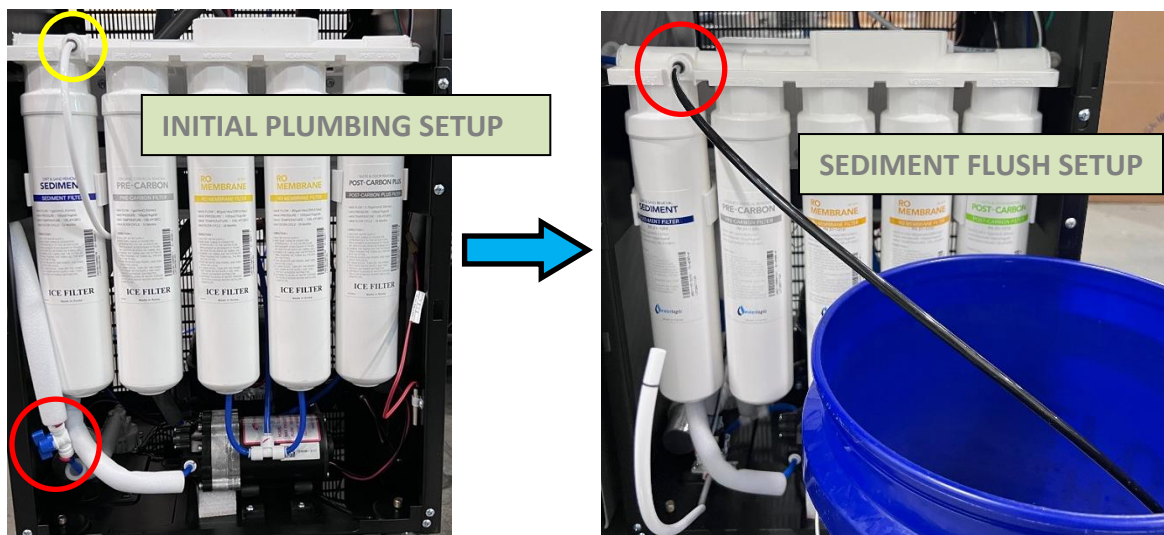

3. Turn on the ¼-turn valve, that was shut off in the previous step. This will begin to flush water through the **sediment filter** and into the bucket. Allow the water to flush through the filter for 3min, which in most cases will be about 2-3 gallons. Shut off the ¼-turn valve.
4. Remove the sediment filter by turning it counter-clockwise. ***ONCE REMOVED, BE SURE TO NOT LOSE THE TWO BLACK O-RINGS INSIDE THE TOP OF THE FILTER.**
5. Remove the Pre-Carbon Filter and the Mineral Filter the same way.
6. Install the **Pre-Carbon Filter** into Filter Head #1 (see below). With the flush tube still running to drain, open the ¼-turn valve and allow water to flush the filter for 3 min. Once complete, shut the ¼-turn valve off.

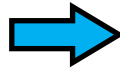

- Remove the Pre-Carbon filter and install the Mineral Filter into Filter Head #1 (see below). **This part is very important: Disconnect the flush tube from the front of the manifold, then disconnect the water supply line running into the left side of the manifold. Now reinstall these tubes in the opposite ports they were removed from. The water supply should plug into the front port, and the drain line (running to a bucket) should be plugged into the left port. This will allow you to “reverse flush” the Mineral Filter.** With the flush tube still running to drain, open the ¼-turn valve and allow water to flush the filter for 3 min. Once complete, shut the ¼-turn valve off.

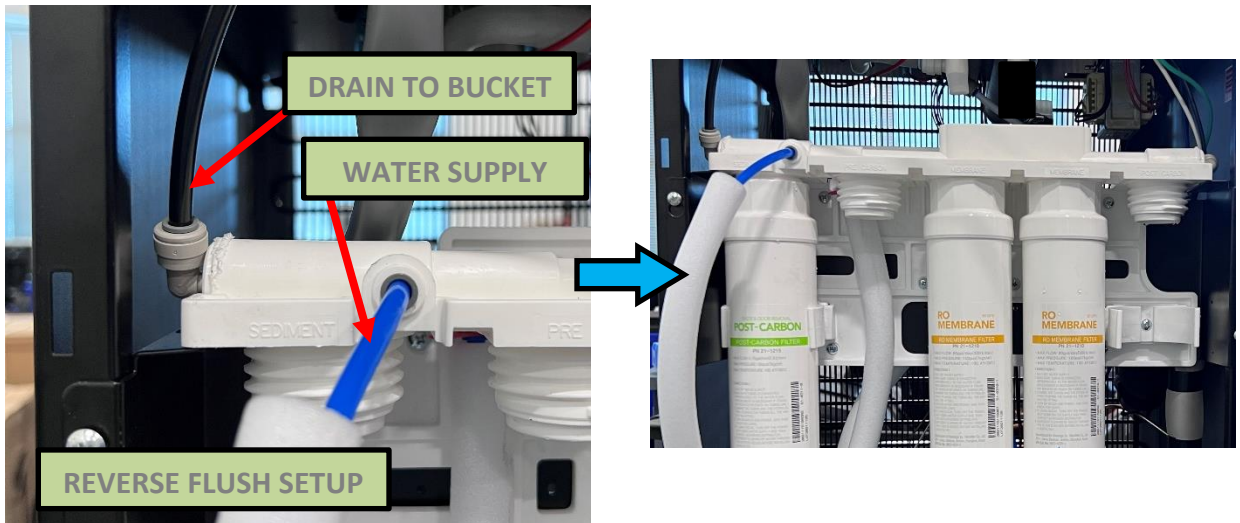

- With the ¼-turn valve shut off, remove the flush line from the manifold and return the water supply to the left side port. Return all filters to their original position. Ensure all filters retained both black o-rings and firmly tighten. **Return the white tube to the front port of the manifold.**



9. Disconnect the line at the outlet port (right side port) of the manifold, and insert the tube used to flush to the bucket. Open the ¼-turn valve and allow the whole series of filters to flush for 3min to the bucket.

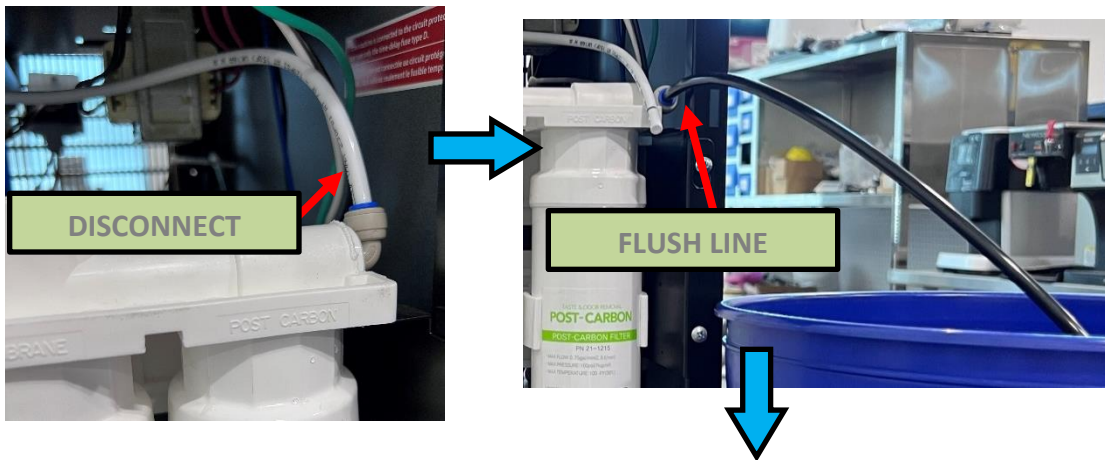

10. Once flushed, shut off the ¼-turn valve. Disconnect the drain to bucket line, and reinstall the original plumbing line to the right side outlet port of the manifold. Once this is done, the flushing procedure is complete.

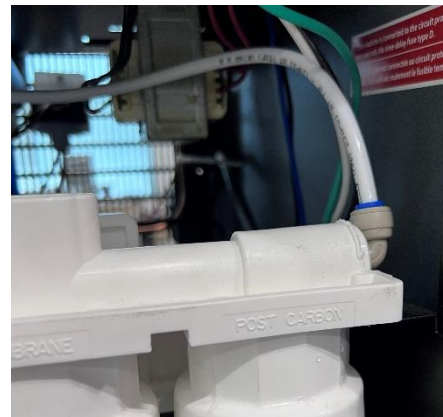

INSTALLATION

It is very important to follow all instructions listed. Failure to do so may cause the system to not operate properly and may impact the long-term reliability of the system.

1. Always check local plumbing codes before tapping into water supply line and drain line. Tap into the water source with an approved connector.
2. Check incoming water pressure and ensure it is between 50-70PSI. If the water pressure is above 70PSI then a pressure reducing valve must be installed and set to lower the pressure to the optimal water pressure between 50-70PSI.
3. Determine the best installation location. Consider user convenience, electrical access, and water access. The unit performs optimally if within 2- feet of a cold-water supply line. Connect only to a cold-water supply. Do not install Feed Water Assembly on the Hot Water Line. Do not place unit where it will be exposed to rain, freezing temperatures or direct sunlight.
4. The rear of the unit should be installed at least 2" from any vertical surface to ensure proper air circulation.
5. Check the available power supply to assure proper electrical service. In the U.S., the voltage specification is 110/120V 60Hz. Voltage outside of this specification will affect the system performance.
6. Connect the water supply line (¼" LLDPE Tubing) to the "IN" port on the back of the machine. Using the same type of tubing, connect the "BRINE" port to a drain, OR to a condensate pump if using one. Using 3/8" LLDPE Tubing, connect the "DRAIN" port to a drain, OR to the same condensate pump if using one. [The filters must be flushed before allowing the machine to fill with water. Refer to the previous section which outlines how to flush the filters while installed.](#) With the filters flushed, turn on the water supply and ensure the ¼-turn valve just before the filters is open.

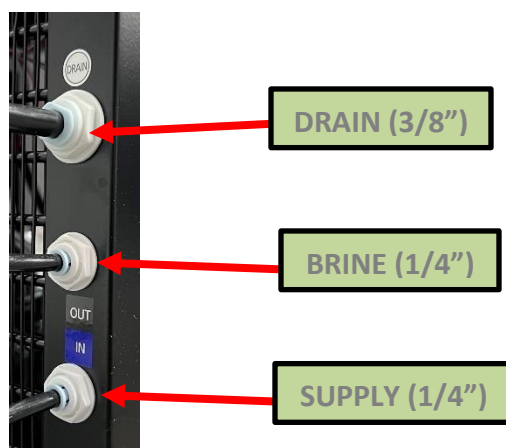

7. Allow the system to fill. This should take roughly 30 minutes. Water will fill the hot tank first, then the cold, and then the ambient tank will be the last to fill.

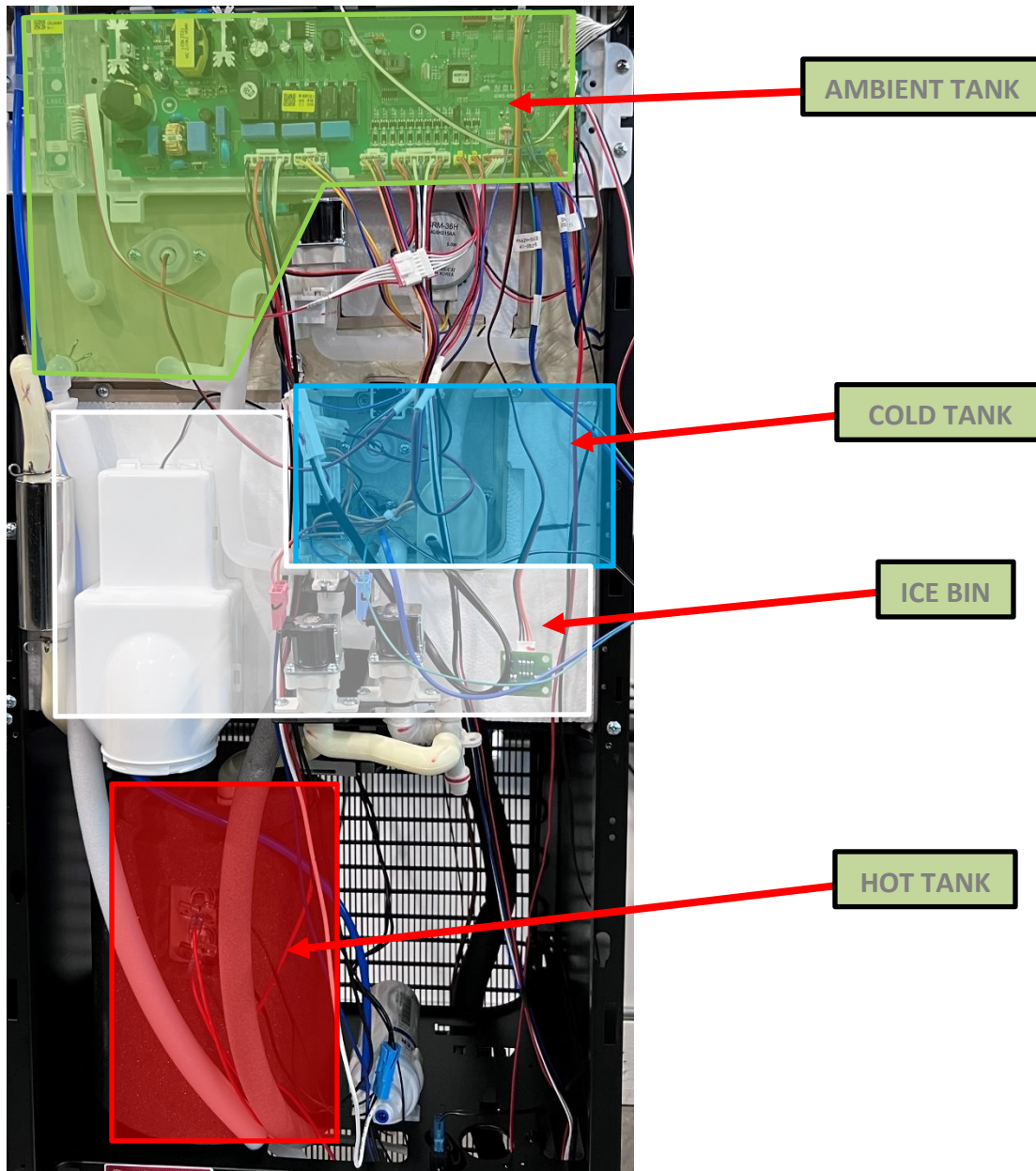

8. The Peak 2000 **WILL NOT** dispense cold water until the water has become chilled to a set temperature. This may take up to 45min (from the water being turned on) to reach temperature, at which time cold will become selectable as a dispense option. Once the cold water is chilled, the ice process will begin, and the first batch of ice should be heard falling within an hour of turning the water on.
9. After an hour, dispense hot and cold water and ice. Ensure all functions operate properly.

SANITIZING AND SERVICE

Sanitize the reservoir using an approved cleaner. Follow all instructions on sanitizing and flush with fresh water through the drain until odor and taste is acceptable.

⚠️ WARNING! USE PROPER PERSONAL PROTECTIVE EQUIPMENT

Always ensure proper ventilation and use proper personal protective equipment such as gloves and eye protection when using chemicals. Refer to Material Safety Data Sheet for specific requirements of each chemical product. Take all necessary precautions to prevent sanitizer from contacting eyes, clothing, and any other surfaces in could damage (carpets).

⚠️ DANGER! ELECTRICAL SHOCK HAZARD.

Do not plug in unit unless qualified. Only qualified personnel who have read and understand this entire manual should attempt to install or service this unit.

Accessing the Ambient Tank

During the following steps you should check for any leaks or loose fittings.

1. Pull the unit away from wall to access the back. Remove the two screws at the back of the top cover. Slide backwards and lift away from the unit. Set this cover aside.



2. Rotate the center cap by twisting counterclockwise. The Ambient tank should be full of water. If not, add several gallons of water to the tank or allow it to fill via supply water. Add an appropriate amount of approved cleaning agent to the inside of the tank. If scrubbing is required, completely remove lid by disengaging tabs around perimeter of lid to gain access to the ambient tank. Allow the mixture of cleaning agent and water to sit in tank for several minutes.



Sanitizing the Ambient, Cold, and Hot Tanks

3. Place a pitcher under the dispense nozzle. Using the front panel interface, select Cold Water and dispense about a quart of water from the Cold Tank. This will fill the cold tank with the cleaning solution from the ambient tank. Now, dispense the same amount of Hot Water using the front panel interface.
4. Remove the front lower panel of unit. To do this, remove the Drip Tray by pulling out and away from unit. Ensure that the Red Seal stays with the Drip Tray. Remove the screw behind where the drip tray sat. Press down on the top of the lower front panel and tilt the top edge outward, then lift the panel up and away from unit.

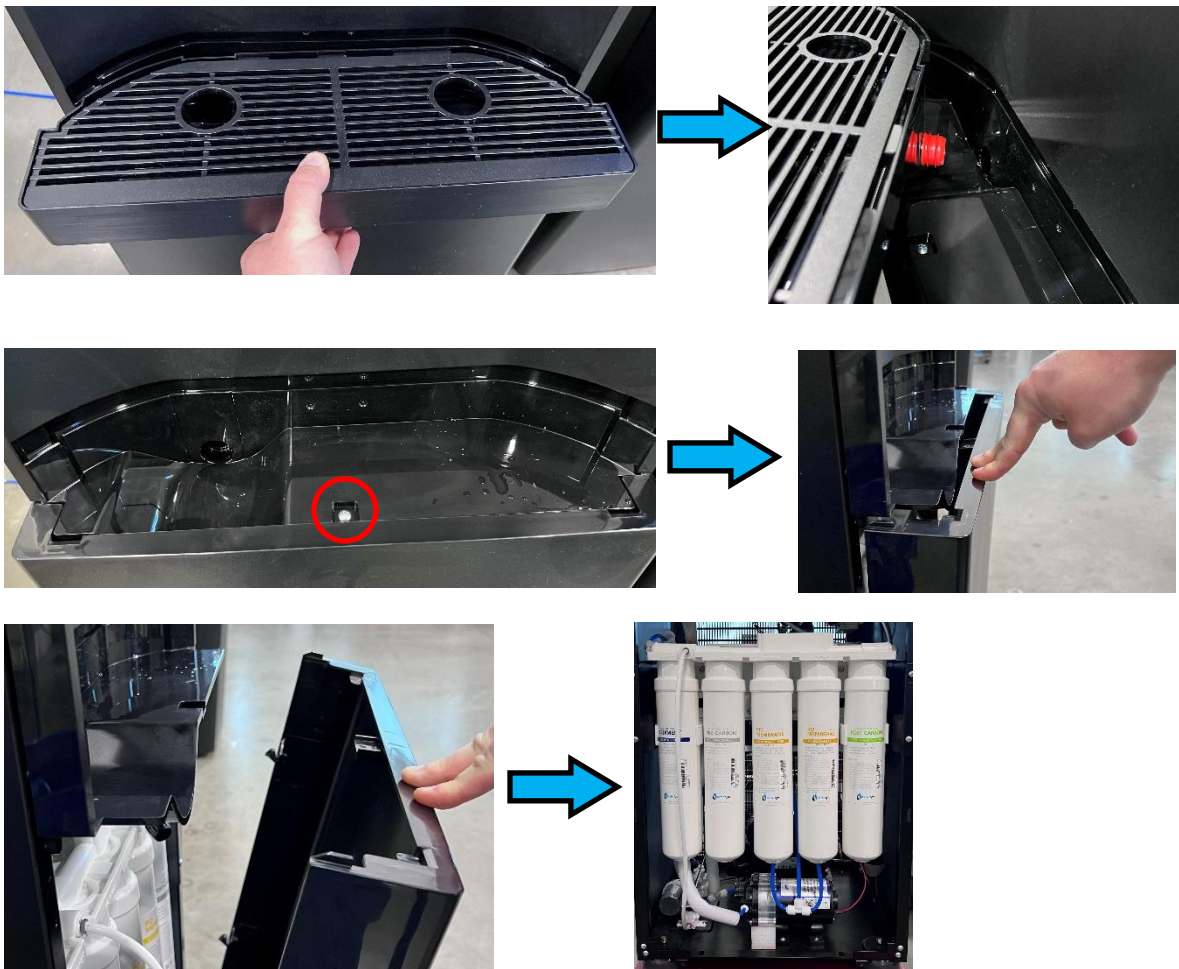

5. Locate the Drain Valve, just above the filter manifold. Locate the Drain Switch located on the underside of the shelf that the Drain Valve is mounted to and turn the switch “ON.” The unit should begin a repetitive chime indicating it is in Drain Mode. The unit will not replenish water while this switch is activated.

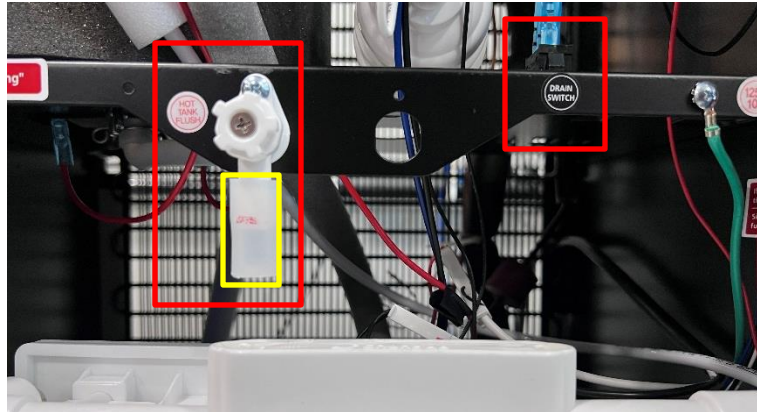

6. Remove the silicone cap covering the Drain Valve. Using 3/8” poly-hose, attach the hose to the Drain Valve nipple and run to drain or a bucket. Open the Drain Valve (turn counter clock-wise) and allow the water and cleaner mixture to drain into the bucket. Close the Drain Valve when water has drained. Empty the bucket into the drain.



7. Using the bucket, or the water supply line, refill the Ambient Tank from the top. Repeat step 6, and allow fresh water to drain from the Ambient Tank through the Hot Tank and into the bucket. Repeat this process 1 more time with fresh water. Once finished, close the Drain Valve.

8. Fill the Ambient Tank with fresh water again from the top. Now dispense Cold Water using the front panel interface until the Cold Tank is depleted. Repeat this step one more time. Once complete, turn the Drain Switch “OFF,” and allow the machine to refill with RO water.
9. Check all water temperatures for taste and smell before reassembly. Return lower front panel, the ambient tank lid, and the top cover to original positions.

Ice Dispensing Spout Cleaning Method

1. Turn the ice dispense faucet to the left, unscrew from spout and remove.

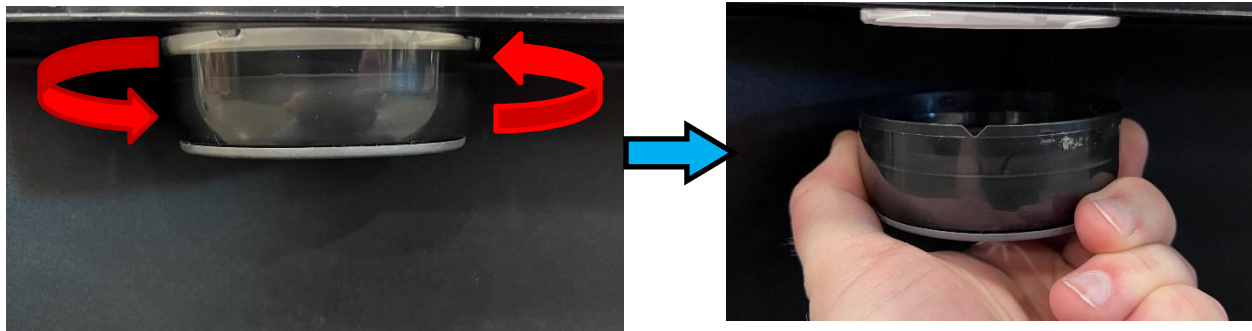

2. Wipe the inside of the faucet with a soft cloth and cleaning agent.
***DO NOT use detergents, thinners, benzene, or wax for cleaning. This may cause discoloration or peeling off and may cause health problems.**
3. After cleaning, assemble the ice dispense spout by turning it to the right and screwing it back on.

Drip Tray Cleaning

1. Pull the drip tray out for cleaning. The rear nozzle of the drip tray has a double gasket and may require a firm pull to remove.

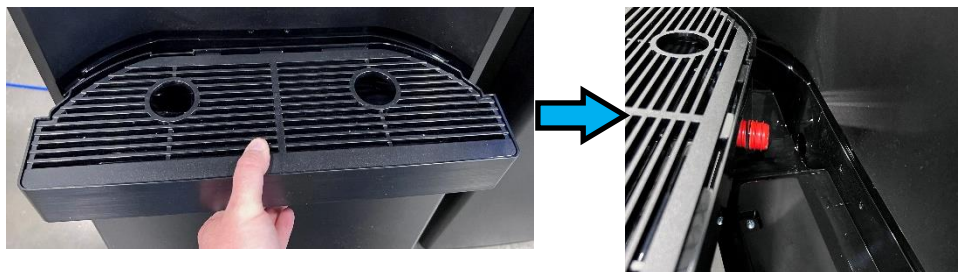

2. Clean the drip tray and grill with a soft cloth or sponge with hot running water and approved cleaning agent. Dry off.
3. Push the drip tray back into the unit.

Water Dispensing Spout Cleaning Method

1. First, remove the two screws at the back of the top cover and remove by sliding the cover towards the back and lift away. There are two screws behind the top corners of the front upper panel, remove these. Lift and pull the front panel away from machine, and place on top temporarily.



2. Locate the two screws holding the Dispense nozzle assembly in place and remove them. Pull the nozzle assembly out of the Dispense Spout and push aside.

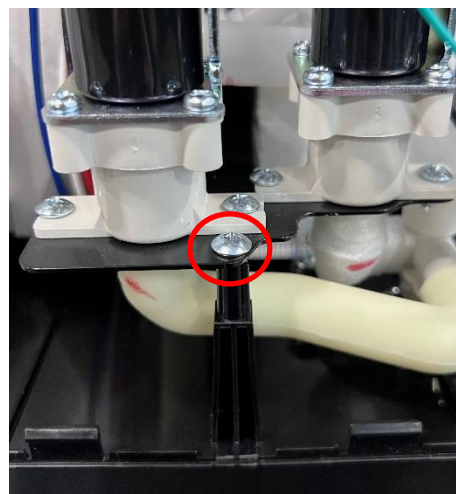

3. Remove the three screws holding the Dispense Spout to the Panel. Remove the Spout. Clean the Dispensing Spout with a soft cloth or sponge, hot running water, and an approved cleaning agent. Dry off. Reinstall the Dispense Spout and reassemble the unit.



CONDENSATE PUMP SETUP

The *Culligan Peak 2000 Ice and Water Dispenser* should have its drain and brine line plumbed to a drain, but a condensate pump can also be installed externally to aid in pumping the water from these two lines to drain access. It is recommended to use a “Little Giant VCMA-20” but any condensation pump should work. Follow the steps below to setup the pump behind the main unit.

1. The condensate pump will require connection to a 120V power source. It is recommended to setup the pump behind the main unit and connect to the same power source.
2. Run the Drain (3/8”) and Brine (1/4”) lines from the ice and water unit into the open receptacles at the corner of the pump.
3. Install a 1/4” MNPT x 3/8” QC fitting into the center port of the pump. Insert 3/8” LLDPE tubing into the 3/8” QC port of the fitting and run to drain access.
4. Be sure to install a 3/8” check valve on the drain line between the pump and drain access.

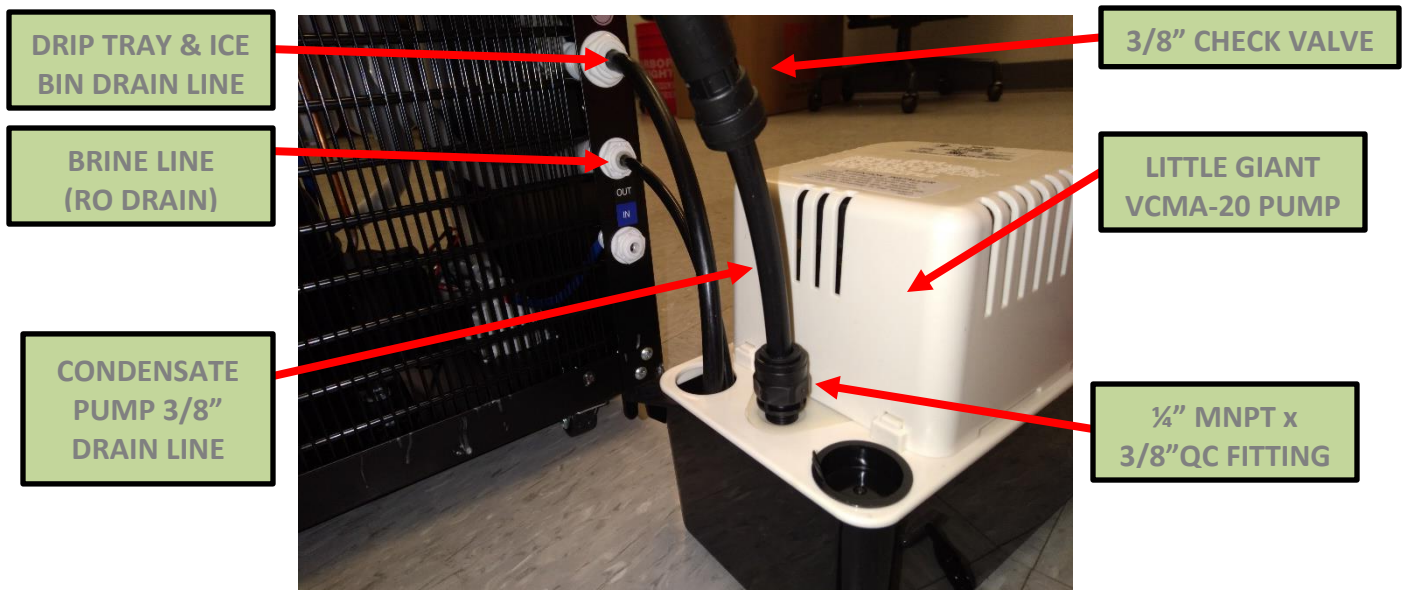

FINAL INSPECTION

After installation and sanitization, verify the following:

1. There are no leaks or loose components.
2. The hot water is over 160°F.
3. The cold water is below 50°F.
4. Confirm acceptable product water flow.
5. If the system is not filling, then check the water supply and also make sure the leak stop has not been tripped. ***The leak stop can be reset by removing the cap below the unit and draining the water out.**
6. Ensure the systems exterior is clean and all components are in place.

Other items to check:

1. Once the system has been flushed it should remain plugged in and water should, at a minimum, be dispensed occasionally. ***Avoid storing in your vehicle or warehouse with residual water in the tank, this will result in a bad taste after installation.**
2. Always drain the system before moving it. It is not necessary to drain the hot tank completely if installing the same day. Leaving water in the hot tank will allow you to turn the hot tank on immediately after installation of the system but if left overnight may result in a taste complaint.
3. Never lay the system on its side.

RESETTING THE HOT TANK OVERLOAD THERMOSTAT

In the event of a “dry heat” scenario during installation, or if the water supply is blocked to the hot tank, overload thermostats are installed on the Hot Tank to prevent an unsafe heating situation and prevent damage to the unit. If these thermostats sense heat that is too high, they will trip and break the power circuit to the heating element. When this happens, the Overload Thermostat must be manually reset.

CAUTION!: Disconnect the machine from its power source before attempting the next steps. Failure to do so could cause electrical shock.

To do this, remove all front panels of the unit and locate the hot tank. On the surface of the hot tank, where a section of insulation is cut away, the overload thermostat is mounted to the metal round of the tank. There is a small red/pink button in the center of the thermostat that must be pressed to reset the thermostat. Doing so will restore a continuous path for power to reach the heating element. Before doing so, ensure that water dispenses from the unit during the hot water dispense operation. If water flows from the hot tank, the tank is primed and full of water. Continue with resetting the thermostat. Water will begin heating, and hot water should be available within 5-10 minutes.

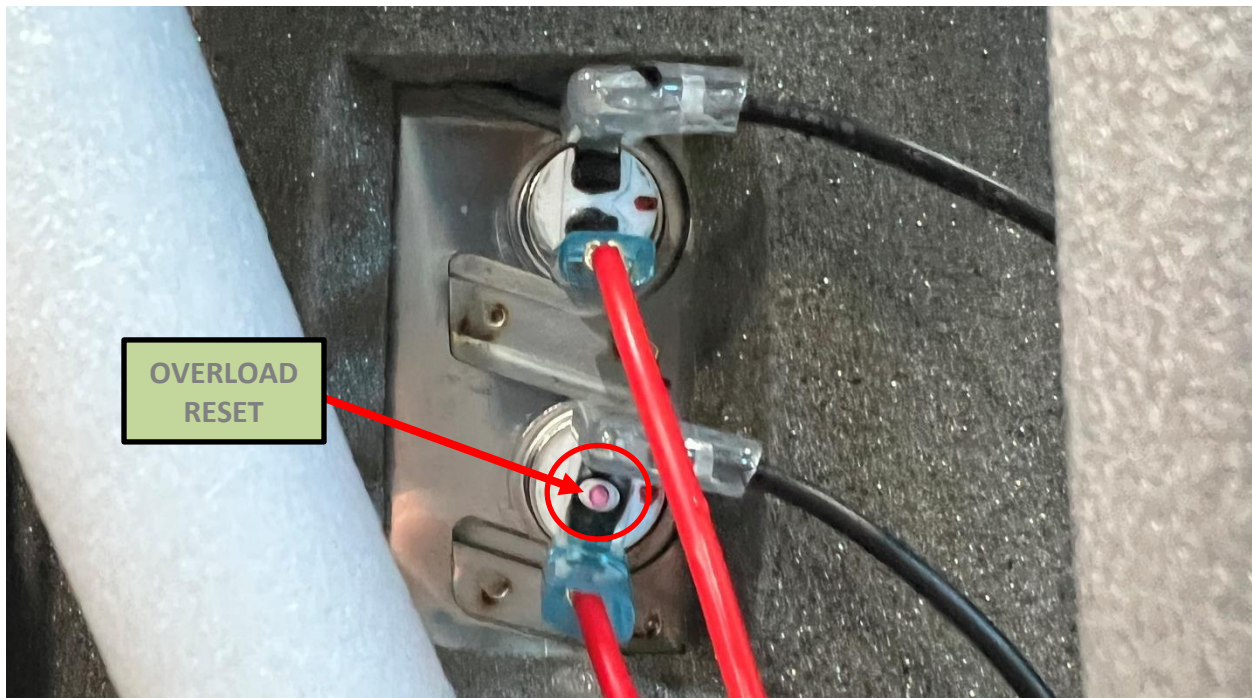

PREVENTATIVE MAINTENANCE

The following is an outline of preventative maintenance that should be performed on yearly or semi-yearly basis to keep the unit running in top shape.

1. Change filters according to the filter change schedule. Always rinse new filters using the same procedure as the original filters.
2. Drain the system and use an approved cleaning agent to sanitize the system as outlined in the sanitization section.
3. Check all fittings for signs of scale or wear and replace as needed.
4. Check solenoids for proper function. Dripping solenoids should be replaced immediately.

Every 5 years, in addition to the above, perform the following:

- Replace all internal fittings and tubing.
- Replace solenoids.

SYSTEM INSPECTION

When changing filters or performing service, the following items should be completed:

- Visual Inspection
- Hose & Fitting Inspection
- Electrical Inspection
- Pressure and Flow Test
- Clean the exterior of system and condenser coils on rear of system.
- Temperature Check (Cold water should be below 50°F, Hot water should be above 160°F)
- TDS Check
- Hot Tank Switch On
- Site Cleanup

WARRANTY PROCEDURE

Procedure for PEAK 2000 warranty evaluation:

Contact CULLIGAN technical support and provide the following information:

- Serial number
- Failure
- Full details around failure
- Water pressure into the system
- Tap TDS
- TDS out of the cold and hot tanks
- Pictures

Depending on the situation, technical support may request more information. Upon approval, CULLIGAN will process warranty credit or replacement part to be fulfilled

PEAK 2000 DIAGNOSTIC ERROR CODES

The *Culligan Peak 2000 Ice and Water Dispenser* can display error codes on the front panel through LED signals for specific system statuses as well as using the several icons to distinguish certain failures or errors. Below is a breakdown of these status and error codes.

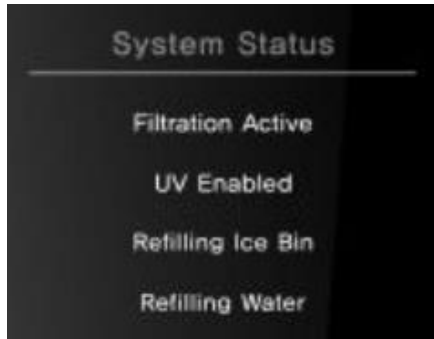

ERROR STATUS	ERROR CAUSE	SOLUTION
“REFILLING WATER” BLINKING	OVER FLOW DETECTED	ENSURE INLET SOLENOID IS WORKING PROPERLY. IF IT IS, REPLACE AMBIENT LEVEL SENSOR
“REFILLING ICE BIN” BLINKING	NO ICE AND NO COLD WATER	UNIT IS NOT PRODUCING ICE OR CHILLING WATER IN THE COLD TANK, REPLACE SURROUNDING TEMP SENSOR.
	COLD WATER LEVEL NOT DETECTED	IF THE COLD WATER SOLENOID IS WORKING CHECK THE COLD WATER LEVEL SENSOR.
	ICE TRAY LOCATION NOT DETECTED	ENSURE ICE TRAY COUPLER IS NOT BROKEN. IF NOT, CHECK MICRO SWITCHES FOR CONTINUITY. CHECK THE MOTOR IS WORKING PROPERLY
	COOLING OPERATION FAILURE	ENSURE CIRCULATION PUMP IS WORKING PROPERLY. REPLACE IF NOT. CHECK COMPRESSOR FOR HIGH HEAT, CALL TECHNICAL SUPPORT.
“REFILLING ICE BIN” & “COLD SELECT” BLINKING	COLD & SURROUNDING TEMP SENSOR FAILURE	REPLACE COLD AND SURROUNDING TEMP SENSOR
“COLD SELECT” BLINKING	COLD TEMP SENSOR FAILURE	REPLACE COLD TEMP SENSOR
“AMBIENT WATER SELECT” BLINKING	SURROUNDING TEMP SENSOR FAILURE	REPLACE SURROUNDING TEMP SENSOR
“HOT WATER SELECT” BLINKING	ICE TEMP SENSOR FAILURE	REMOVE ICE TEMP SENSOR (C6 ON PCB)

PEAK 2000 SELF-DIAGNOSTIC MODE

The *Culligan Peak 2000 Ice and Water Dispenser* has a diagnostic mode that can be activated through a specific sequence of sensor activation. This diagnostic mode allows the machine to perform manual checks of several processes and components and give an error signal if it finds anything wrong.

How to Enter Diagnostic Mode

1. Place a container (or two) to catch both dispensed water and ice on the drip tray.
2. Unplug the unit. Reconnect to power.
3. Within 5 minutes of reconnecting to power, ***SIMULTANEOUSLY*** activate the Water Dispense function ***AND*** the Ice Dispense function for 5 seconds. Once 5 seconds has passed, the unit will chime, all LEDs will light, and water and ice will cease dispensing. Diagnostic Mode is now ready.

How to Begin the Diagnostic Function

4. Activate the following functions in order: Ice Dispense (all LEDs will turn off) > Temp Select > Water Dispense > Water Dispense > Water Dispense > Ice Dispense. Step away from the unit so as not to accidentally activate any other functions.
5. The unit will begin the Diagnostic Function for the next 30 seconds.
6. Once the unit completes the Diagnostic Function it will display any blinking error codes. If no errors found, it will only display solid lit LEDs.
7. If any errors are found, address those issues. Refer to the Error Codes section on the previous page. To exit the diagnostic mode, disconnect the unit from power, then reconnect to power.

TROUBLESHOOTING INDEX

1. No water or Slow Production (Hot/Cold/Ambient)
2. Hot Water Dispense produces water that is not hot
3. Display is unlit, unit not operating
4. Dispense operation does not dispense water (any temperature)
5. Overfill error (constant chime)
6. Cold Water not cold
7. Ice not being produced
8. Ice is produced, but does not dispense OR dispenses very slowly

1. No water or Slow Production (Hot/Cold/Ambient)

Possible Cause	Solution
Check Water Production after Filtration Bank	Ensure water is pushing past the filters. If flow is slow or stopped after filters, one or more filters may be plugged and will need to be replaced. Also check that the booster pump is running. A failed pump could cause very low flow through the filtration system.
Check the Leak Stop	If water gets into the bottom of the system, then the leak stop will shut off the water supply. Drain any water from the leak stop using the plug on the back of the unit. The water line AFTER the leak stop may need to be disconnected then reconnected to break any vacuum that may have developed in the line.
Supply Water Pressure	Check the water pressure into the filter bank and confirm adequate pressure, should be 50-70psi. Ensure the ¼"-turn valve just before the filtration system is open.

2. Hot Water Dispense produces water that is not hot

Possible Reason	Solution
Overload Thermostat Tripped	Locate the Overload Thermostat mounted on the front of the hot tank. Press the red button to manually reset the thermostat and return the hot tank power circuit to normal operation.
Hot Tank Wiring Failure	Damage or disconnection of one of several connections in the hot tank circuit. Check all wiring, ensure no connections have arced.

3. **Display is unlit, unit not operating**

Possible Reason	Solution
Power Cord Disconnected	Ensure the power cable is properly plugged into the wall power outlet.
Tripped GFCI	Reset GFCI outlet.
Blown Fuse	Check the Fuse inside the black housing behind the filtration bank. Fuse should be white. If black or gray, fuse has burned. Replace.

4. **Dispense operation does not dispense water (any temperature)**

Possible Reason	Solution
Dispense Capacitive Sensor Failure	Sensor may have failed. Ensure the unit chimes when the sensor is activated. If no chime, this may indicate the sensor has failed and will need to be replaced.
Dispense Solenoid	If the unit chimes when the sensor is activated, check corresponding dispense solenoid for failure. Solenoids can sometimes “stick” open and become very hot to the touch. Replace in either case.

5. **Overfill Error (Constant Chime)**

Possible Reason	Solution
RO Filtration System Bypass	If the RO filtration system has been bypassed, the delay built into the level sensors in the unit will be overwhelmed and the unit will fill past its full point. Drain some water from the unit and DO NOT bypass the RO filtration system.
Ambient Level Sensor Failure	Check water level in the ambient level sensor. If water is to the top white dot, this will set off the overfill alarm. Investigate why the unit overfilled. If RO system is not bypassed, and flow from the filtration system is normal, replace the ambient level sensor.

6. Cold Water not cold

Possible Reason	Solution
Cold Water Temp Probe Failure	If ice is being produced, but the cold water is not cold, replace the cold water temp probe.
Circulation Pump Failure	If Cold water is not cold AND Ice is not being produced, check that the circulation pump is working and pushing water to the ice tray in the compartment below the ambient tank. Replace if not working correctly.
Ice Tray Rotation Failure (Motor or Coupler)	If Cold water is not cold AND Ice is not being produced BUT the circulation pump is working, check that the tray in the ice-making compartment is rotating. If it is not, determine if the Tray Coupler is broken and replace if it is. If not, check for proper operation of the Tray Motor. Replace if necessary.

7. Ice not being produced

Possible Reason	Solution
Circulation Pump Failure	If Cold water is not cold AND Ice is not being produced, check that the circulation pump is working and pushing water to the ice tray in the compartment below the ambient tank. Replace if not working correctly.
Ice Tray Rotation Failure (Motor or Coupler)	If Cold water is not cold AND Ice is not being produced BUT the circulation pump is working, check that the tray in the ice-making compartment is rotating. If it is not, determine if the Tray Coupler is broken and replace if it is. If not, check for proper operation of the Tray Motor. Replace if necessary.
Compressor and Gas System	If Circulation Pump, and the Ice Tray Motor and Coupler are working properly, check if compressor is operating normally. Check heat levels. Compressor body should be warm to the touch and condenser should also be slight warm. If compressor is extremely hot and condenser is cold, call technical support. If compressor is not running, call technical support.

8. Ice is produced, but does not dispense OR dispenses very slowly

Possible Reason	Solution
Dispense Capacitive Sensor Failure	Ice Dispense Sensor may have failed. Ensure the unit chimes when the sensor is activated. If no chime, this may indicate the sensor has failed and will need to be replaced.
Check Ice Dispense Door Operation	If the unit chimes when the Ice Dispense Sensor is activated, but no ice is dispensed, inspect the Ice Dispense Door for proper operation. Ensure all electrical connections are secure. If Ice Dispense Door mechanism is unresponsive, replace the door unit.
Ice Turntable Failure	If dispense sensor is operating correctly, and dispense door is opening, check that the Ice Turntable inside the unit is turning and pushing ice out of the unit. If unresponsive, call technical support.